



CAMINE MODULARE PENTRU APLICATII DE TELECOM

MODULARE ACCES CHAMBER
FOR TELECOM

ARQUETA MODULAR
PARA TELECOM

Alternativa eficienta pentru camine traditionale.
A cost-effective alternative to traditional manholes.
Una alternativa eficaz a las arquetas tradicionales.



DESPRE NOI

Noi cei de la HIDROSTANK am fi încântați să colaborăm cu dumneavoastră în proiectele viitoare de fibre optice cu furnizarea soluției noastre de camere modulare de acces fabricate din material PP pentru telecomunicații.

Aceste camere modulare, certificate deja de companii precum Telefónica, Vodafone, Orange... permit antreprenorului să realizeze construcția civilă mult mai rapid.

HIDROSTANK este o companie spaniolă cu mai bine de 20 de ani de experiență pe piața autohtonă și o activitate externă în creștere în Europa, LATAM, Orientul Mijlociu, Africa... În acest timp, HIDROSTANK a lucrat îndeaproape cu detinatori de utilități, proiectanți, antreprenori, instalatori... care au folosit camere HIDROSTANK pentru diferitele lor proiecte.

From HIDROSTANK we would be pleased to collaborate with you in future fiber rollouts with the supply of our innovative PP modular access chambers for telecom.

These modular manholes, already certified by companies like Telefónica, Vodafone, Orange... enable the contractor to do the civil construction much faster.

HIDROSTANK is a Spanish company with more than 20 years of experience on the home market, and an increasing foreign activity in Europe, LATAM, Middle East, Africa... During this time HIDROSTANK has been working narrowly with utilities, designers, contractors, installers... that have been using HIDROSTANK manholes for their different projects.

Desde HIDROSTANK estaríamos interesados en colaborar en futuros despliegues mediante el suministro de nuestras innovadoras arquetas de polipropileno para canalización de telecomunicaciones.

Las arquetas modulares HIDROSTANK, homologadas por Telefónica, Vodafone, Orange... permiten agilizar los despliegues.

HIDROSTANK es una empresa española con más de 20 años de experiencia en el mercado español, y una creciente actividad exterior (Europa, LATAM, África, Oriente Medio...). Durante este tiempo HIDROSTANK ha estado colaborando estrechamente con distintas administraciones, ingenierías, constructores, instaladores... que han confiado en nuestras arquetas para sus diferentes proyectos.

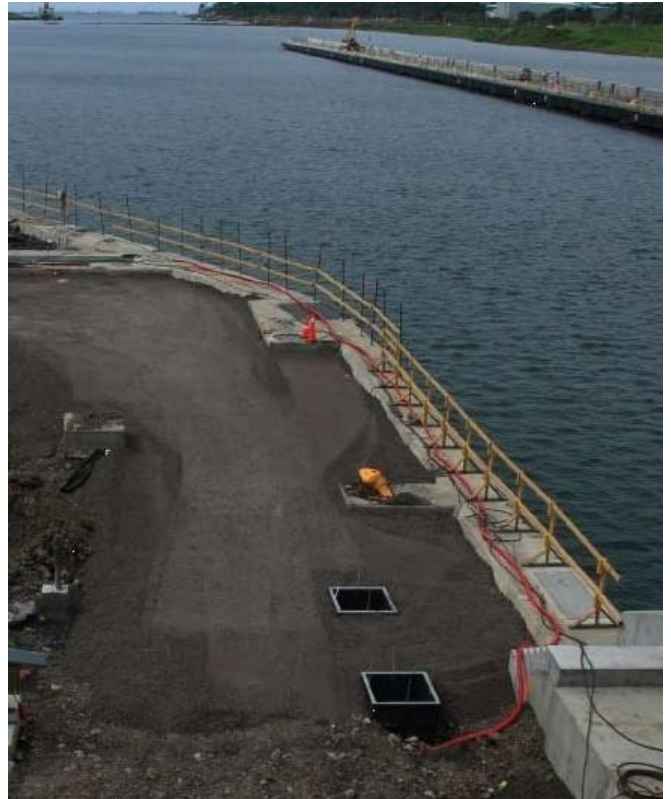

Canalul Panama

20 de ani de experienta in proiecte internationale

20 years experience on international projects

20 años de experiencia en proyectos internacionales



Clitate certificata



Suport tehnic



Prietenos cu mediu



IDEAL PENTRU PROIECTE DE FOR PROJECTS OF PARA PROYECTOS DE



- ✓ **Infrastructura: autostrazi, drumuri, aeroporturi, linii de tren...**
 Infrastructures: highways, roads, airports, railways...
 Obra civil: autopistas, carreteras, aeropuertos, ferrocarriles...
- ✓ **Dezvoltari imobiliare, constructie de locuinte, cladiri industriale...**
 Real Estate, housing construction, industrial facilities...
 Urbanización, Polígonos industriales...
- ✓ **Proiecte de parcuri fotovoltaice**
 Greenfield photovoltaic projects
 Proyectos fotovoltaicos

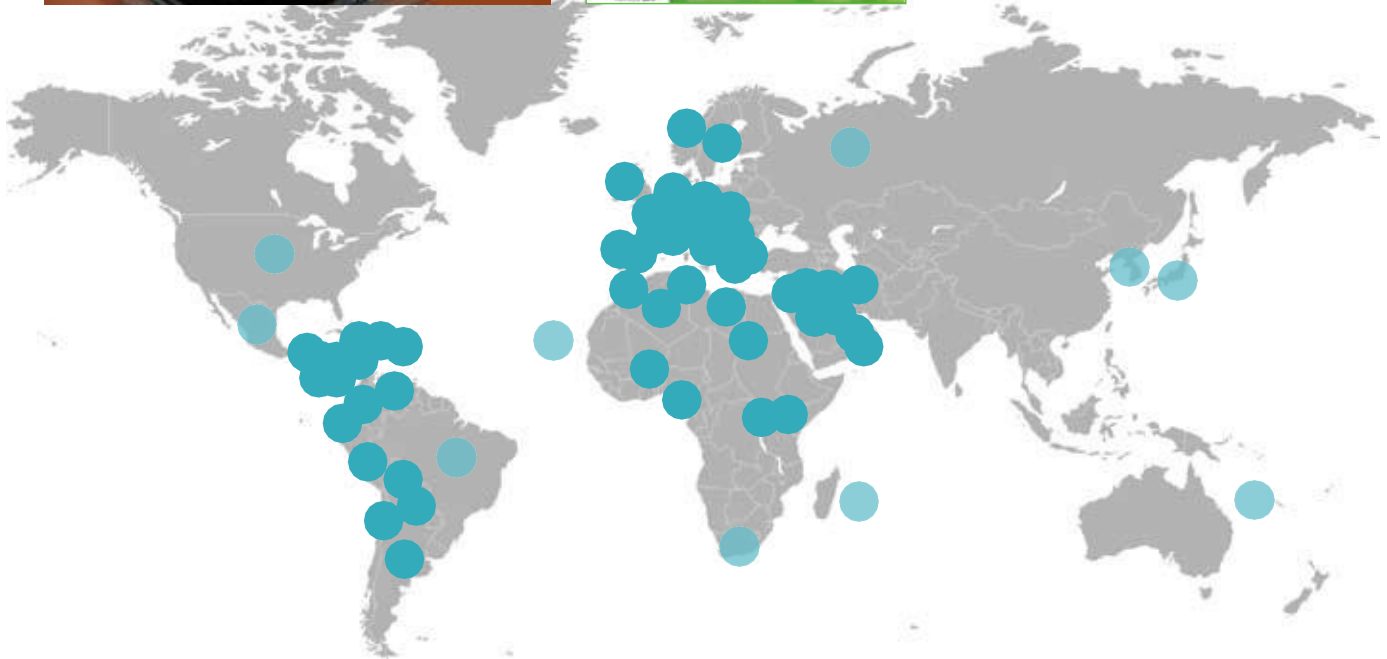

CAMINELE NOASTRE MODULARE

OUR MODULAR ACCESS CHAMBERS

nUESTRAS ARQUETAS MODULARES

Caminele modulare de la HIDROSTANK reprezinta o alternativa rentabila si eficienta fata de caminele traditionale din beton sau caramida, permitand o instalare usoara, rapida si sigura.

HIDROSTANK modular chambers are a cost-effective alternative to traditional concrete or brick manholes, enabling an easy, fast and secure installation.

Las arquetas modulares HIDROSTANK son una alternativa eficaz y competitiva a las arquetas tradicionales de hormigón o ladrillo, y permiten una instalación fácil, rápida y segura.



PRIETENOS CU MEDIU
100% MATERIAL RECICLAT



REZISTENTE (pana la D400, EN 14802)
SELF-RESISTANT (UP TO D400, EN 14802)
AUTO-RESISTENTE (HASTA D400, EN 14802)



INSTALARE RAPIDA, USOARA SI SIGURA
QUICK, EASY & SAFE In STALLATIOn
INSTALACIÓN FÁCIL, RÁPIDA Y SEGURA
INSTALLATION SÛRE ET FACILE



VERSATIL
VERSATILE
VERSÁTIL



CALITATE
RIDICATA
HIGH QUALITY
ALTA CALIDAD



DEPOZITARE SI TRANSPORT EFICIENT
OPTIMUM STOCKAGE & TRANSPORT
ÓPTIMO ALMACENAJE Y TRANSPORTE



COST EFICIENT
COST EFFECTIVE
PRECIO COMPETITIVO



Logistica eficienta
(depozitare & transport)
Better logistics
(transport & storage)
Mejor logística (transporte
y almacenaje)

Usor de asamblat si de
realiz. orificii de
intrare
Easy assembling & inlets
making
Fácil montaje y
realización de
acometidas

Nu necesita utilaje la
instalare
No heavy machinery
required
No requiere maquinaria
pesada

Fara betoane la instalare
No concrete
backfilling required
No se requiere relleno
de hormigón

Rezistent la infiltratii si
la agenti chimici
Chemical and
weathering resistant
Resistente a
agresiones químicas y
climáticas

Usor de adus la cota
Easy to make it higher
Fácilmente recrecible

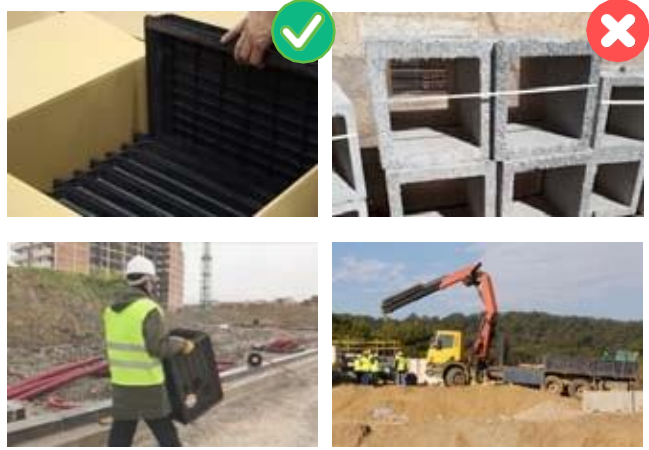

APLICATII

APPLICATIONS APLICACIONES

Telecomunicatii:

Retele de fibre optice: FTTH, HFC, microtubing
Fiber optic networks: FTTH, HFC, microducting.
Redes de fibra: FTTH, HFC, microzanjas.



Electrice:

Iluminat public, distributie de retele electrice 0,4/20kV
Public Lighting, LV & MV distribution.
Alumbrado Público, Distribución en Baja y Media Tensión.



Ideal pentru instalare peste tubulaturi existente
Ideal for existing pipe.
Ideal para tubería existente.



CAMIN DE ACCES SIMPLU

SIMPLE ACCESS CHAMBER ARQUETA SIMPLE

REFERINTA	DIMENSIUNI INTERNE	DIMENSIUNI EXTERNE	INALTIMI	CAPAC
A 35x35	35x35	45x45	40-60-80-100-120	40x40
A 45x45	45x45	55x55	40-60-80-100-120	50x50
A 58x58	58x58	68x68	40-60-80-100-120	60x60
A 68x68	68x68	78x78	40-60-80-100-120	70x70
A 58x45	58x45	68x55	40-60-80-100-120	63x49
A 68x35	68x35	78x45	40-60-80-100-120	75x42
A 68x45	68x45	78x55	40-60-80-100-120	71x46

Dimensiuni in cm / Dimmension in cm / Dimensiones en cm

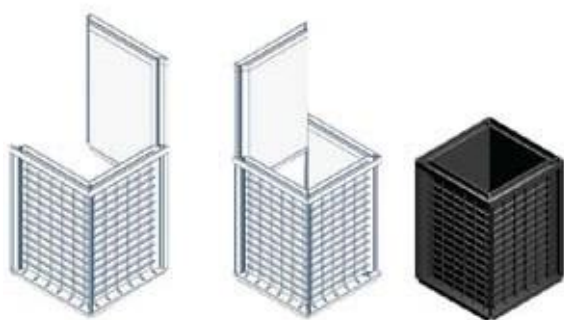

CAMIN DE ACCES ARMAT

REINFORCED ACCESS CHAMBER ARQUETA ARMADA

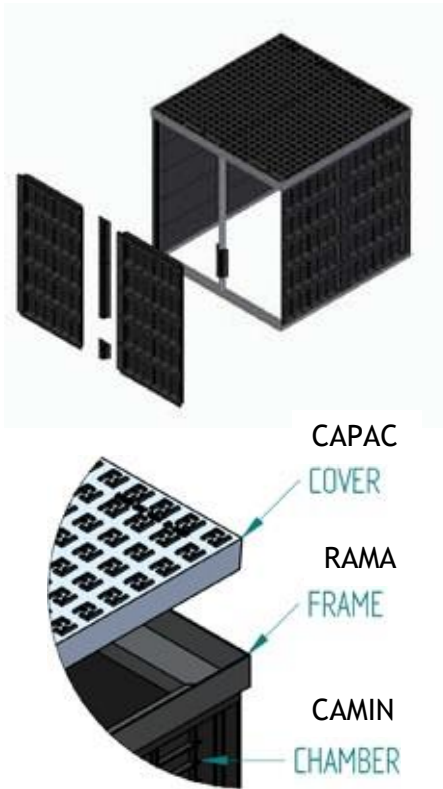

REFERINTA	DIMENSIUNI INTERIOARE	DIMENSIUNI EXTERIOARE	INALTIMI	CAPAC
AAG 80x80	80x80	90x90	60-80-100-120	90x90
AAG 90x90	90x90	100x100	60-80-100-120	100x100
AAG 100x100	100x100	110x110	60-80-100-120	110x110
AAG 113x113	113x113	123x123	60-80-100-120	120x120
AAG 80x35	80x35	90x45	60-80-100-120	90x45
AAG 80x68	80x68	90x78	60-80-100-120	87x76
AAG 90x45	90x45	100x55	60-80-100-120	100x50
AAG 90x58	90x58	100x68	60-80-100-120	95x70
AAG 100x45	100x45	110x55	60-80-100-120	110x55
AAG 113x45	113x45	123x55	60-80-100-120	126x49
AAG 113x90	113x90	123x100	60-80-100-120	119x102
AAG 126x58	126x58	136x68	60-80-100-120	135x69
AAG 126x80	126x80	136x90	60-80-100-120	136x90
AAG 135x58	135x58	145x68	60-80-100-120	148x63
AAG 155x80	155x80	165x90	60-80-100-120	165x90
AAG 155x100	155x100	165x110	60-80-100-120	165x110
AAG 210x100	210x100	220x110	60-80-100-120	220x110

Dimensions in cm / Dimensiones en cm / Mesures en cm

**SOLUTII
PERSONALIZATE
BESPOKE
SOLUTIONS**
**SOLUCIONES
A MEDIDA**



CAPACE

COVERS TAPAS

FONTA
CAST IRON
HIERRO FUNDIDO

COMPOZIT
COMPOSITE
COMPOSITE

OTEL GALVANIZAT
GALVANIZED STEEL
ACERO GALVANIZADO

INCASTRAT
RECESSED
RELLENABLE

BETON
CONCRETE
HORMIGÓN

RAMA INTEGRATA
INTEGRATING FRAME
MARCO INTEGRADO

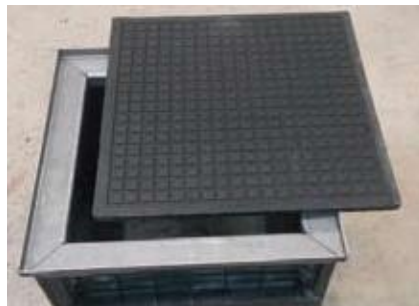
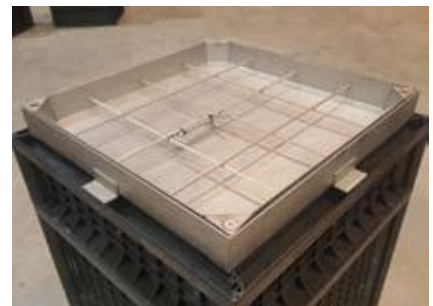
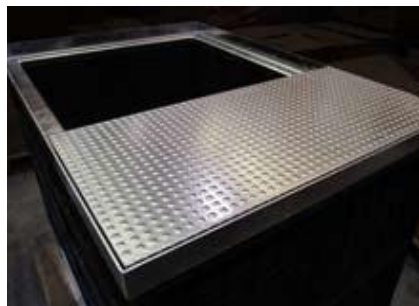

SISTEM DE INCHIDERE
LOCKING SYSTEM
CIERRES

Type 1



Type 2



Type 3



SURUB DE SIGURANTA: *consultati cantitatea minim comandata*
Security Screw: *ask the Minimum Quantity Order (MQO)*
Tornillo de seguridad: *pregunte el pedido minimo*

CAPACE DIN COMPOZIT

COMPOSITE COVERS TAPAS DE COMPOSITE

Capacele din material compozit ofera numeroase avantaje fata de capacele din fonta cum ar fi:

- Izolatie electrica si termica
- Nu se corodeaza
- Mai putine zgomote urbane
- Nu prezinta interes pentru hoti

Composite covers offer numerous advantages over traditional cast iron covers such as:

- Electrical and temperature insulation
- Does not suffer corrosion problems
- Less noise
- Solve problems of theft

Las tapas de composite ofrecen numerosas ventajas frente a las tradicionales tapas de fundición tales como:

- Aislante eléctrico y de temperatura
- No sufre problemas de corrosión
- Menor ruido
- Soluciona los problemas de robos

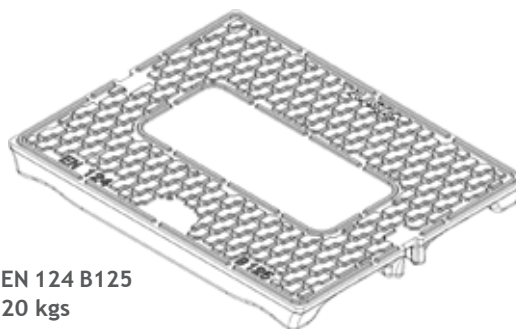

EN 124 B125
20 kgs

REFERINTA CAMIN	DIMENSIUNI EXTERNE RAMA	CAPACE (MM)	MODEL	ORIENTARE
A 58x45	642x507	633x495x54	L1T	
AAG 90x58	1004x642	(2) 633x495x54	½ L4T	
AAG 113x45	1278x507	(2) 633x495x54	L2T	
AAG 135x58	1501x642	(3) 633x495x54	L3T	
AAG 194x58	1995x642	(4) 633x495x54	L4T	



ACCESORII

ACCESSORIES ACCESORIOS

SUPORT CUTII DE JONCTIUNE FO
FIBER OPTIC CLOSURES
CAJAS DE EMPALME



SUPORT DE CABLURI
CABLE BEARERS
SOPORTES PARA CABLE



ALTELE
OTHERS
OTROS



INSTALARE

InSTALLATIOnS
InSTALACIONES



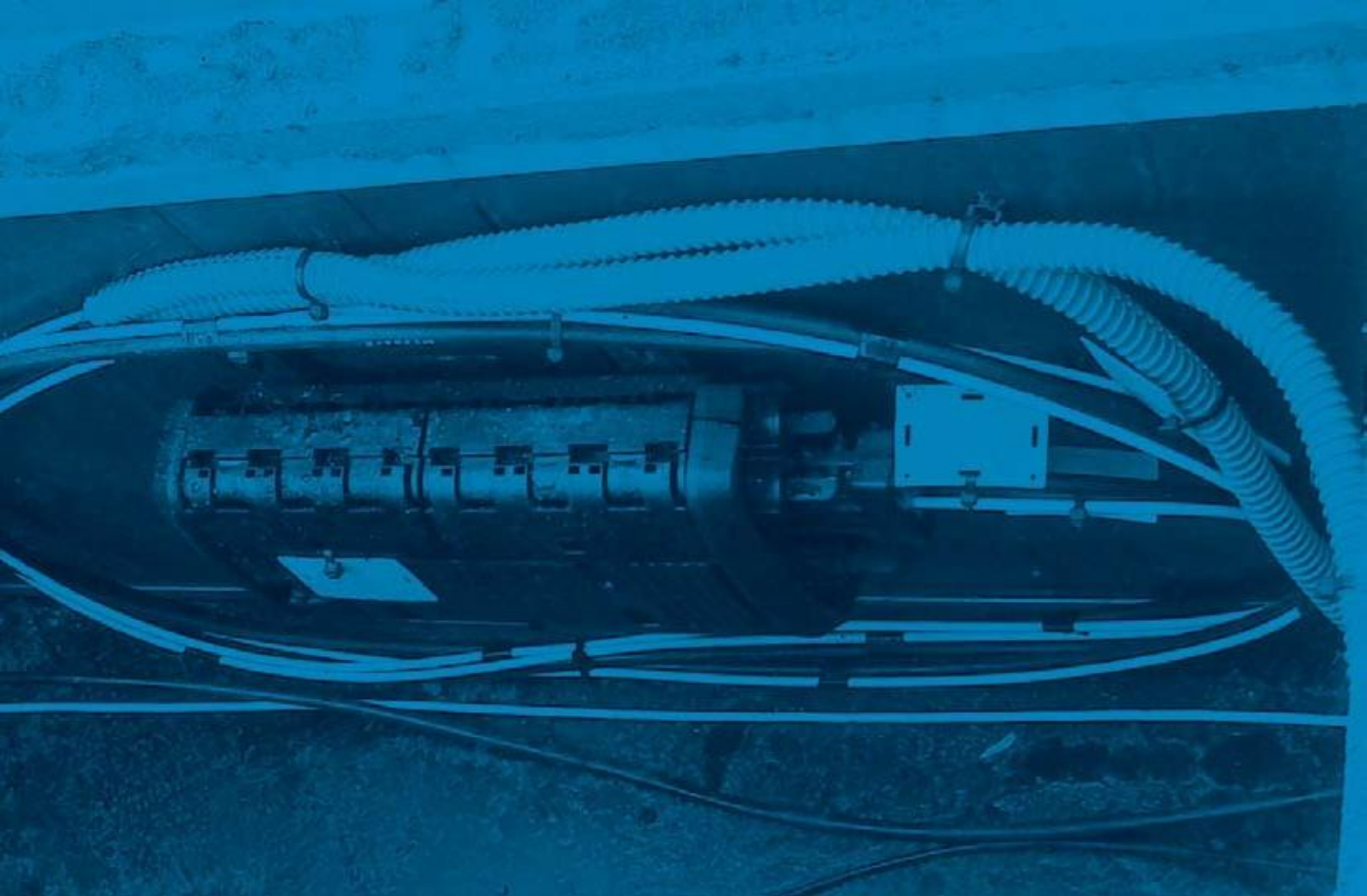

HIDROSTANK

Pol. Ind. La Nava, Calle D nº 15
ES-31300 Tafalla, Navarra
(SPAIN)
Tel. +34 948 74 11 10



www.hidrostantk.com
info@hidrostantk.com



SANPAUL, STR.12, NR.6, JUD. ARAD
Tel: +40722386636
www.optotelcom.ro
office@optotelcom.ro

